

#25271 FLYING CARDINAL ASSEMBLY INSTRUCTIONS

1. Open the Velcro closure on the Front Body Half and insert the Front Body Rod into the Main Hub within the fabric sleeve of the Front Body Half. Reclose the Velcro closure. The completed Strut Assembly should match Diagram A.
2. Attach Wing Fins to Wing Hub. Please note that Wing Fins are inserted at an offset pattern. Make sure Wing Fins are fully inserted into hub holes. You will hear a "click" sound when the pins are in all the way. (Diagram B & C)

PLEASE NOTE: If you make a mistake in the placement of the Wing Fins (i.e. backward, wrong color sequence etc.), you can remove them by carefully inserting a small flat end screwdriver between the base of the Wing Fin Pin and the hub and pushing it up and out.

3. Drive Ground Stake into ground. Slide Support Pole into Ground Stake. Slide Main Hub Assembly with Garden Spinner over Support Pole Ferrule. If you desire extra height, add the extra ground shaft included in this package. (Diagram D)

PLEASE NOTE: Although your Garden Spinner is constructed with UV resistant SunTex™ fabric, to preserve its durability, we recommend taking the Spinner inside during harsh weather or when not in use.

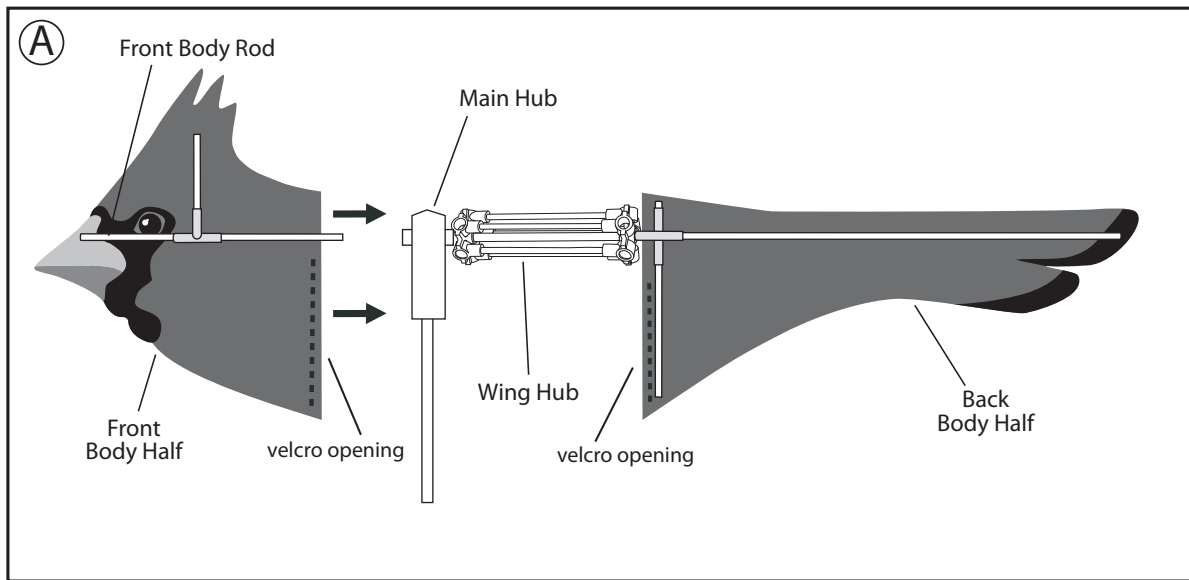

PLEASE NOTE THAT WING FINNS ARE INSERTED AT AN OFFSET PATTERN

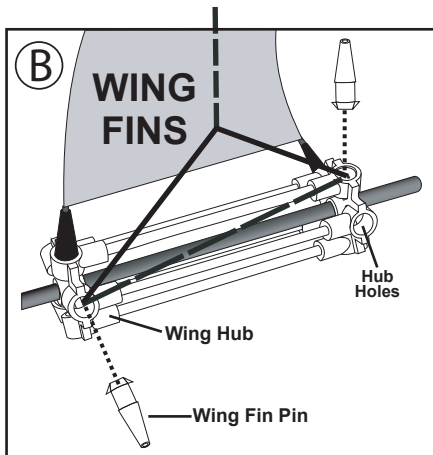

CORRECT ASSEMBLY

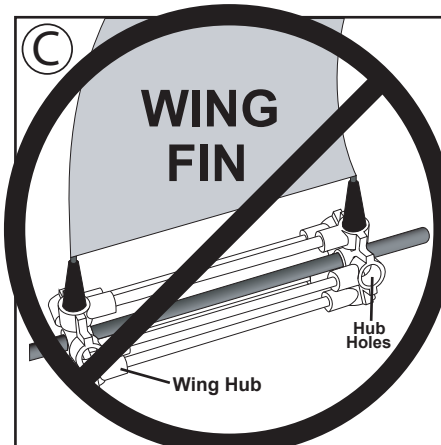

WRONG WAY!!

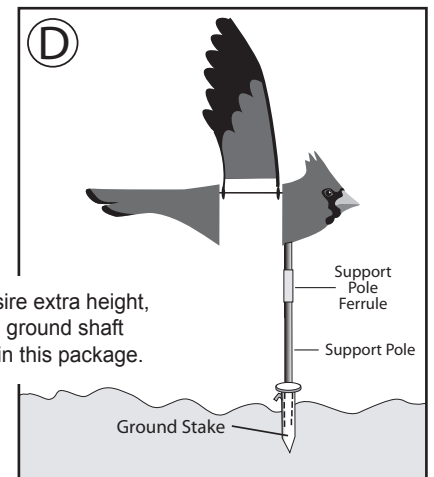

If you desire extra height, add extra ground shaft included in this package.